

Bottom view

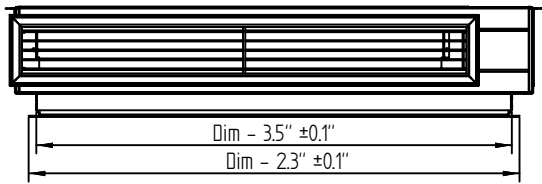

Front view

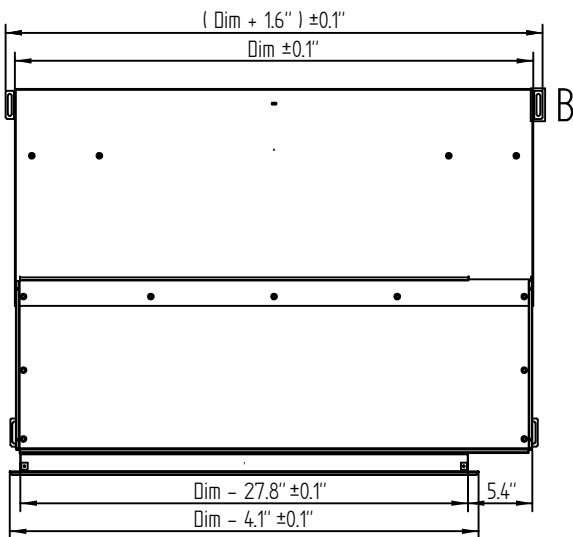

Top view

Left

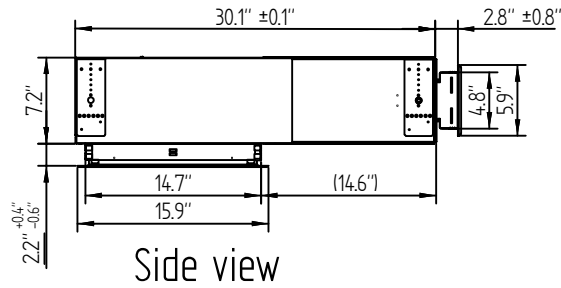

Side view

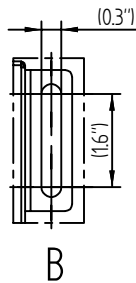

Dim = 30.5", 35.4", 43.3", 51.2" or 59.1"

Back view left

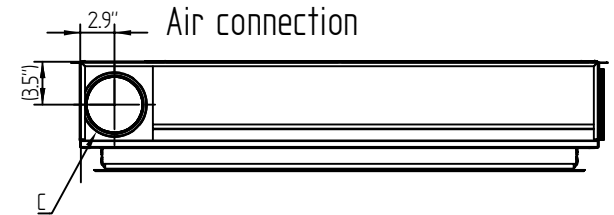

Water connection NC+

Vattenanslutning/
Water connection HC+

Water connection CCO

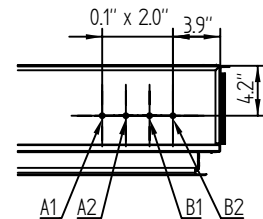
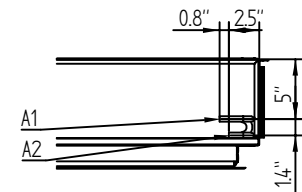
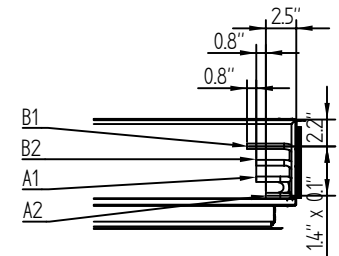

- A1 = Supply cooling $\Phi 12 \times 1,0$ mm (Cu)
- A2 = Return cooling $\Phi 12 \times 1,0$ mm (Cu)
- B1 = Supply heating $\Phi 12 \times 1,0$ mm (Cu)
- B2 = Return heating $\Phi 12 \times 1,0$ mm (Cu)
- C = Primary airduct, $\Phi 125$ mm