

# WCD2 PACIFIC - m

Installation instructions for condensation sensor

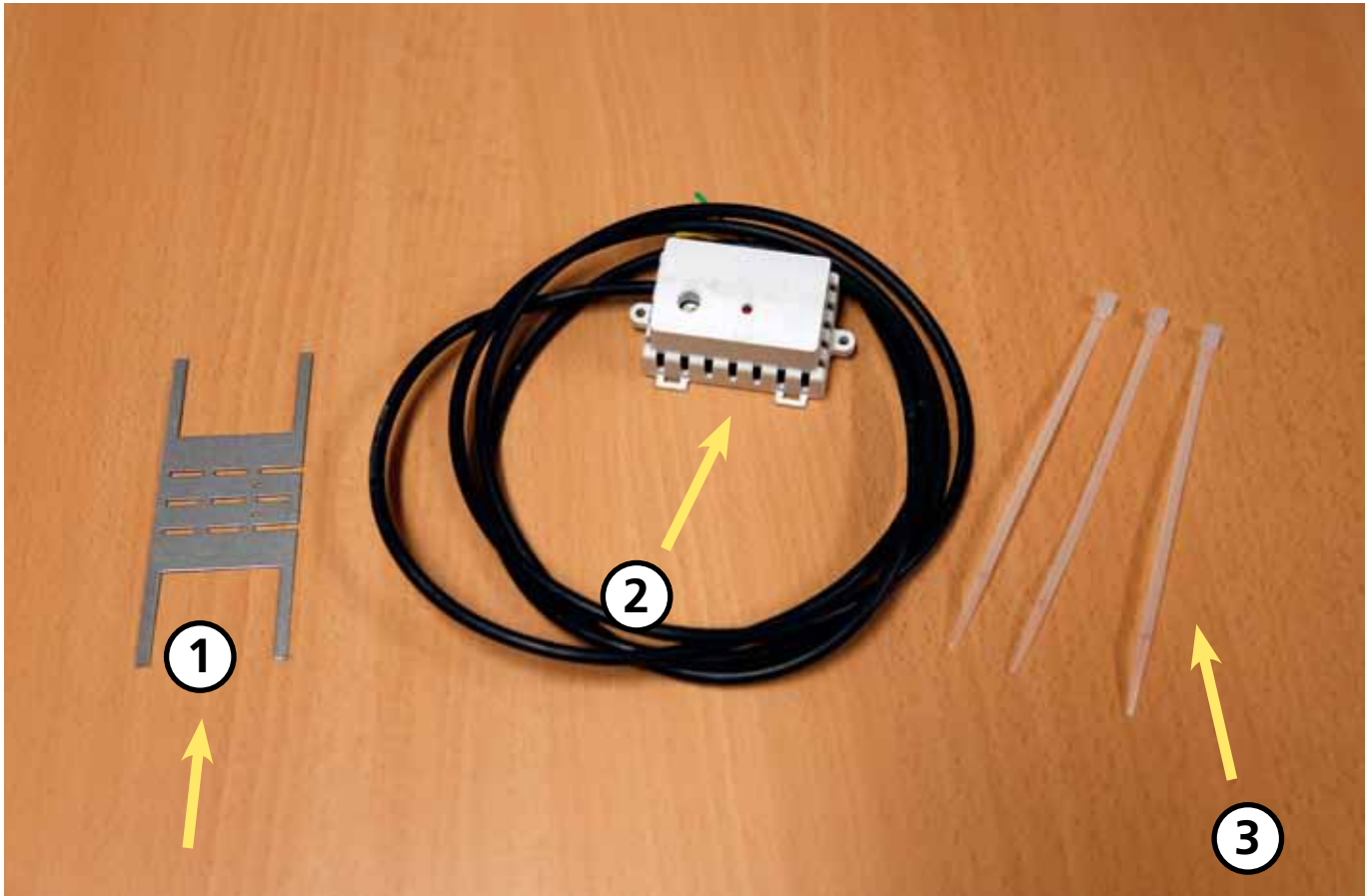

Condensation sensor WCD2

## General description of the Condensation Sensor WCD2 Pacific

The Sensor WCD2 Pacific is designed to meet the requirements to provide early warning of condensing conditions. In case of a problem with the system the sensor is used as a safeguard to avoid condensation from the chilled beam. The sensor operates on dew point temperature rather than a fixed value of relative humidity.

The dew point is calculated from a temperature compensated RH element and a high accuracy thermistor which are thermally bonded to the metal plate of the sensor.

The volt-free contact relay in the sensor is activated when the dew point temperature is below the calculated dew point temperature (there is a safety factor included in the calculated dew point). NOTE: the sensor should be mounted on incoming cooling water pipe and close to the coil.

### LED Indication.

The red LED, visible through the top of the housing, has 4 functions.

1. Short blink once every 15 seconds to show the device is working properly
2. Rapid continuous blinking to show the dew point switching set point is close
3. Continuously ON when the output is switched on.
4. On long flash followed by 2 short flashes to show the temperature element is faulty.

# Condensation sensor WCD2 - PACIFIC

To connect the condensation sensor on a copper pipe.

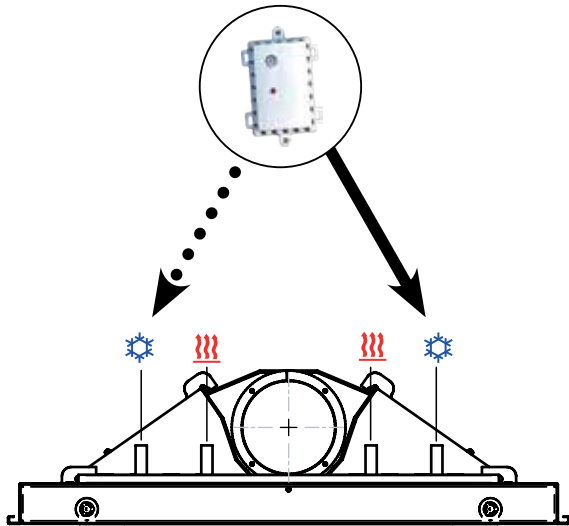

**Note!** The sensor should be mounted on the supply cooling water pipe as close as possible to the coil.

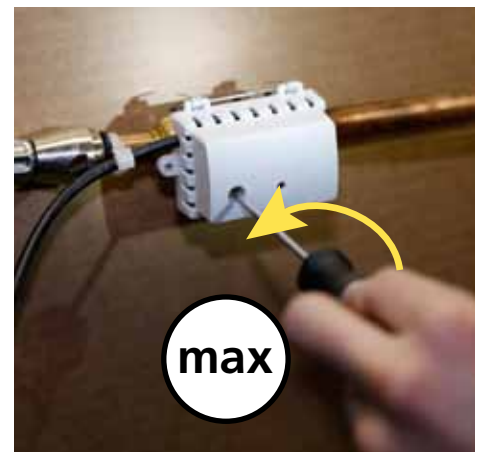
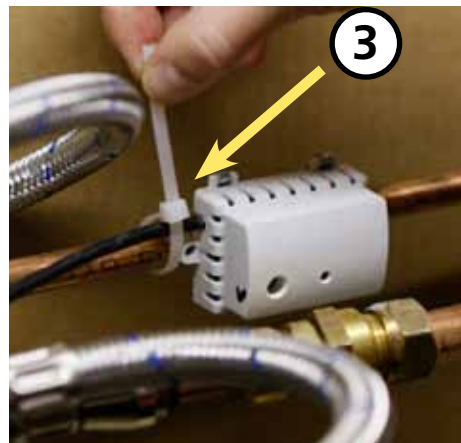
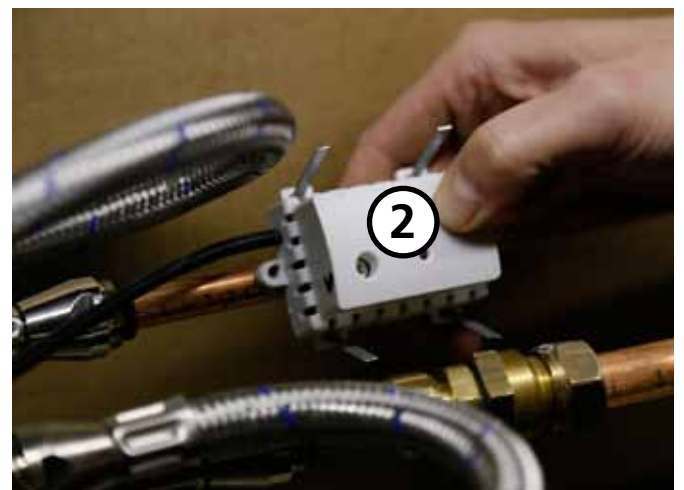
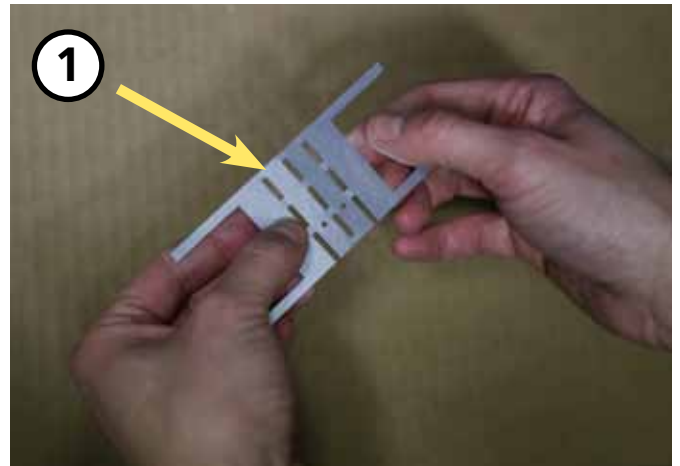

# Condensation sensor WCD2 - PACIFIC

To connect the condensation sensor on a connection nut (when PEX tubing is used).

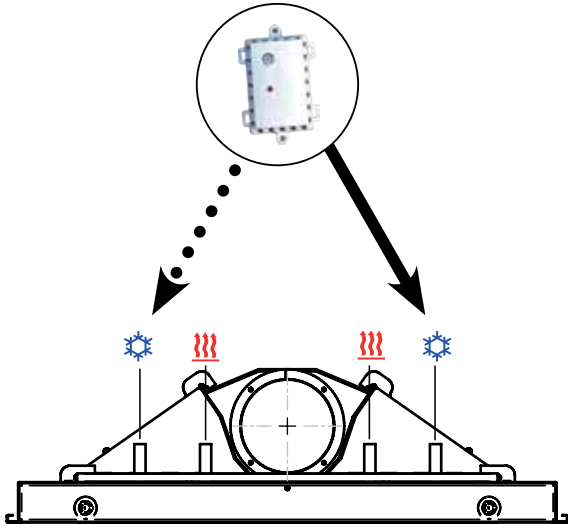

**Note!** The sensor should be mounted on the supply cooling water pipe as close as possible to the coil.

1

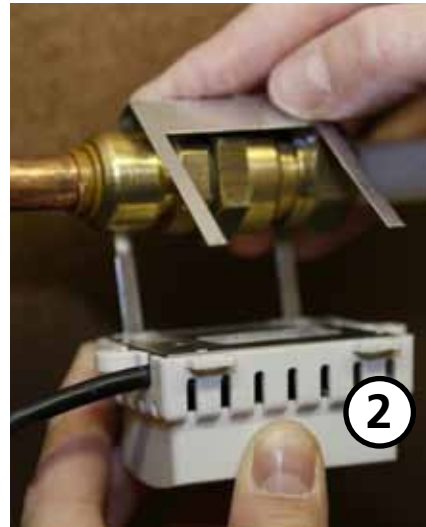

2

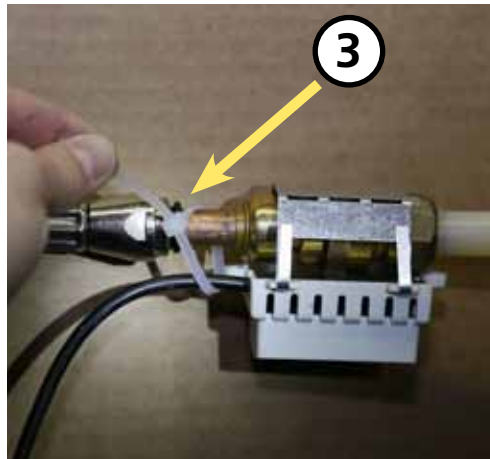
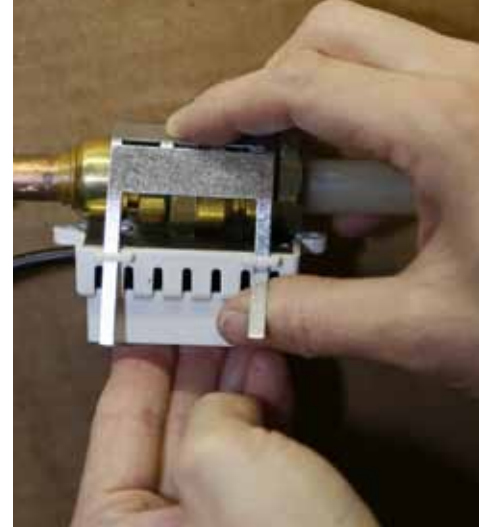

3

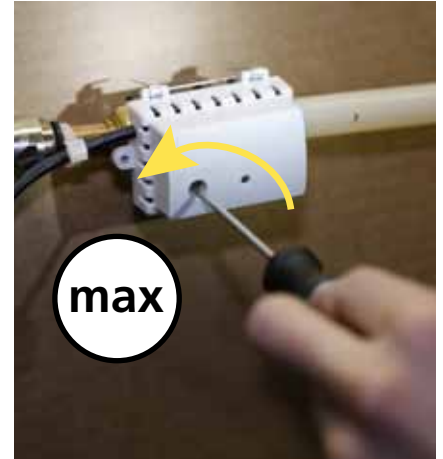

max

Installation WCD2

# Condensation sensor WCD2 - PACIFIC



To connect condensation sensor WCD2 to PACIFIC with CONDUCTOR

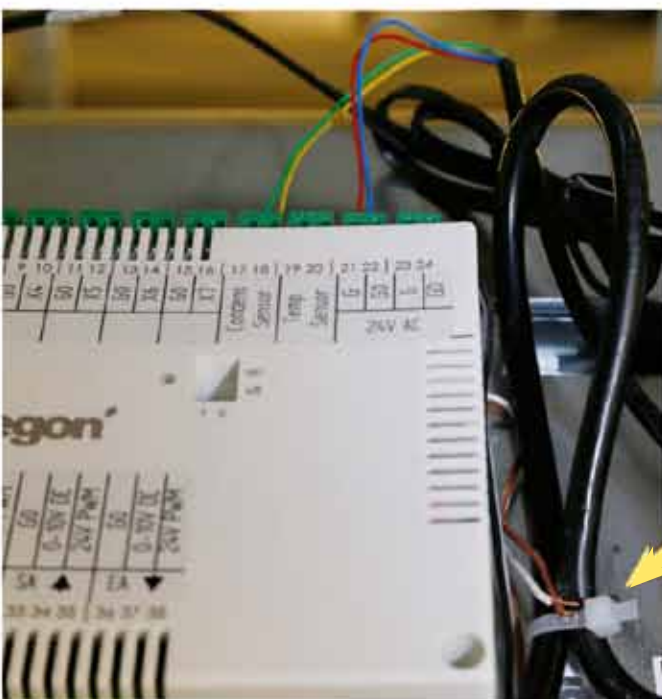
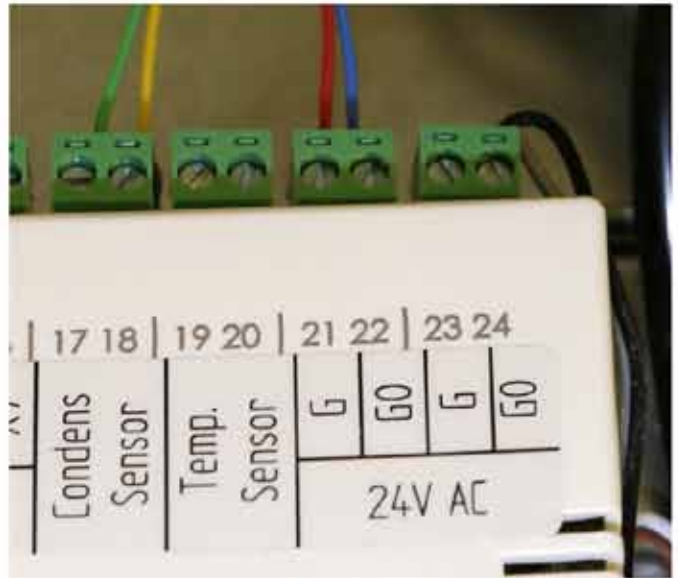
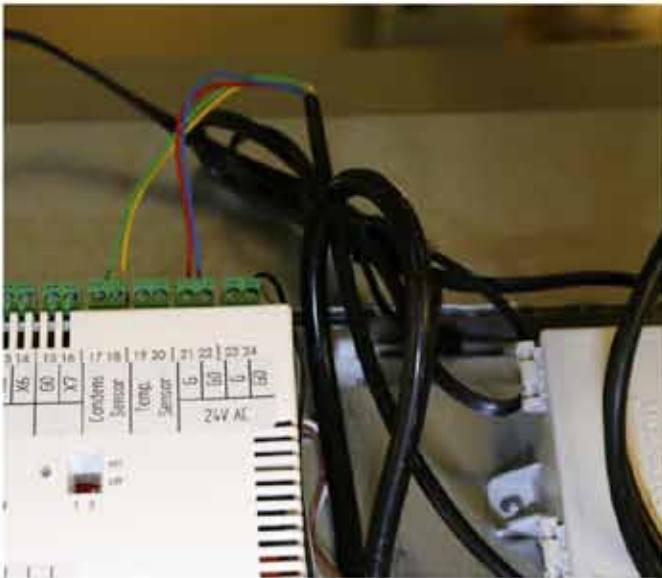
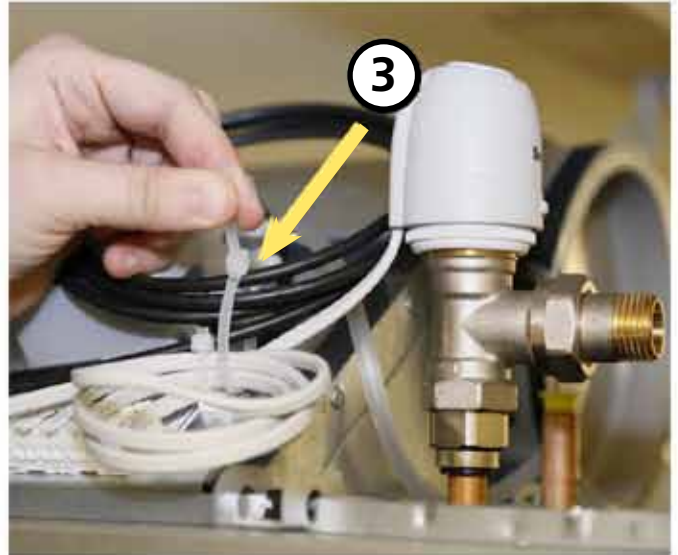

Condensation sensor WCD2	17	Green
	18	Yellow
	21	Red
	22	Blue

To connect condensation sensor WCD2 to PACIFIC with URC1

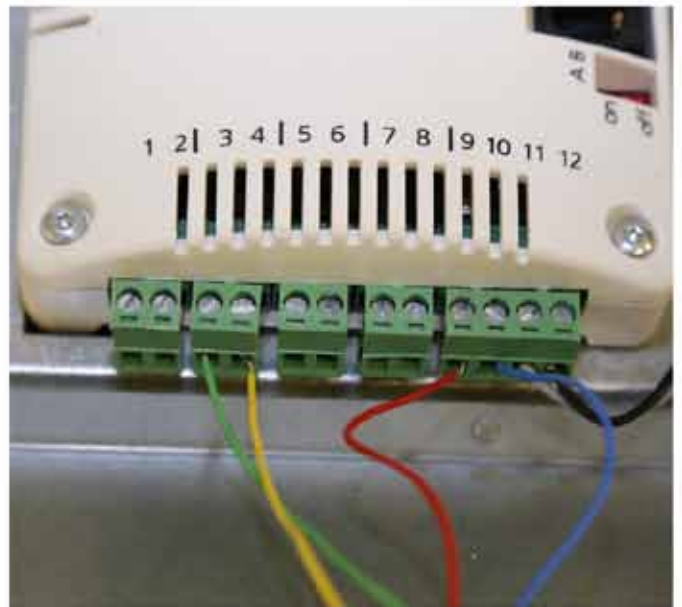
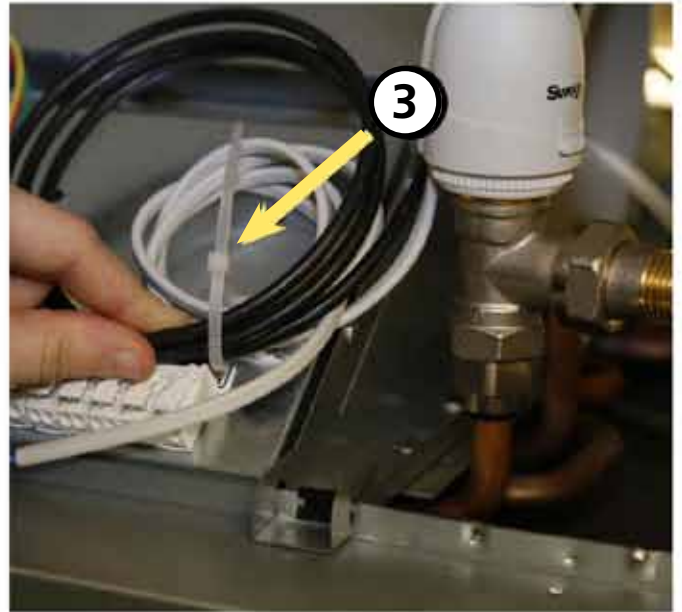
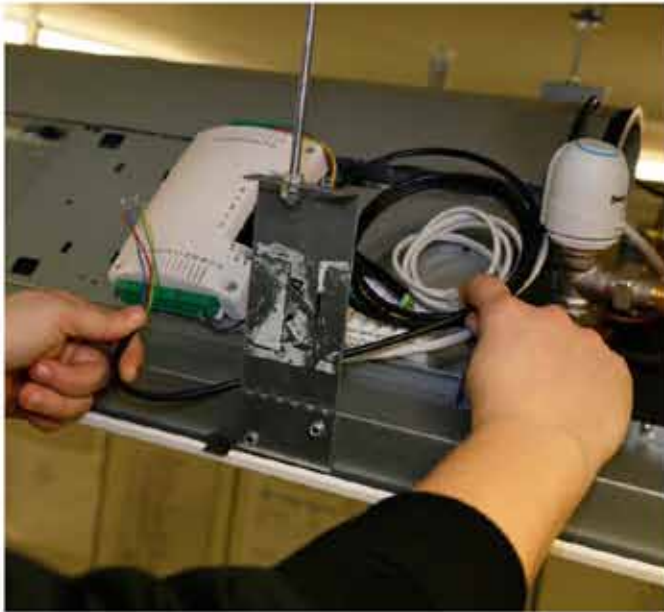

Condensation sensor WCD2	3	Green
	4	Yellow
	9	Red
	10	Blue

Installation WCD2

# Condensation sensor WCD2 - PACIFIC



To connect condensation sensor to PACIFIC with LUNA

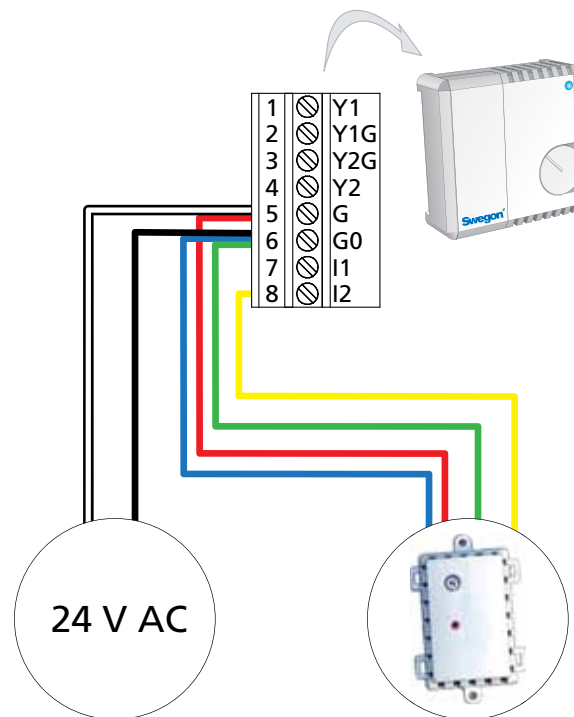
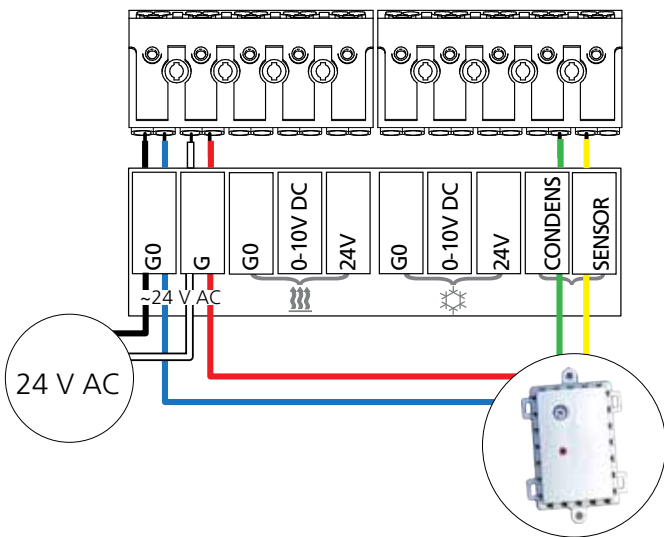
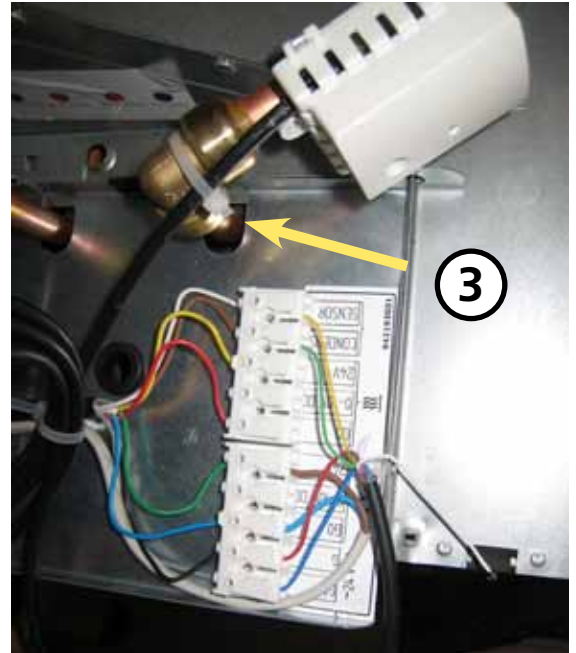
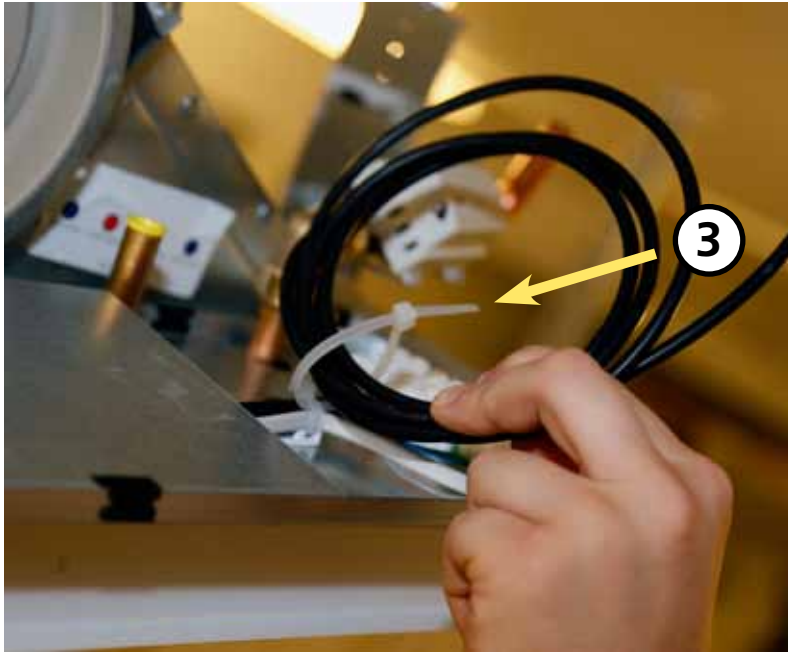

	Colour	Plinth
Condensation sensor WCD2	Blue	G0
	Red	G
	Green	CONDENS
	Yellow	SENSOR

	Colour	LUNA RE-S
Condensation sensor WCD2	Blue	6
	Red	5
	Green	6
	Yellow	8